

Geo-dynamic monitoring using wireless sensor networks

Dan Ștefan Tudose

Computer Science Department
University Politehnica Bucharest
Bucharest, Romania
dan.tudose@cs.pub.ro

Ioan Deaconu, Andrei Mușat

Computer Science Department
University Politehnica Bucharest
Bucharest, Romania

ioan.deaconu@cti.pub.ro, andrei.musat@cti.pub.ro

Abstract— Wireless sensor networks are a cheap and versatile solution for monitoring various environments and elements of an environment. There are a number of such applications used worldwide to monitor areas in which human access is hard or near impossible. The issue with these applications is that they are mainly used by government organizations or for research purposes. They seldom focus on using the data in the interest of safety for the population, such as warning them of natural disasters or assessing the risk of damaged areas left in the wake of a natural disaster. The solution proposed in this article is a low power, low cost wireless sensor which is used to monitor earthquakes and the status of urban structures exposed to earthquakes or other sources of vibration in order to prevent possible disasters.

Keywords— *wireless sensor networks; geo-dynamics; earthquake monitoring; low power;*

I. INTRODUCTION

In recent years, wireless sensor networks have been used more and more often as a cheap and easy to maintain monitoring system. Wireless sensors are adequate tools for monitoring various environments due to a series of characteristics such as:

- low power consumption which increases autonomy and helps reduce the node size (no need to attach large batteries)
- possibility to attach energy harvesting modules which further help to increase their autonomy
- ability to mount numerous sensor peripherals on a small surface
- require a low amount of outside intervention and maintenance
- can operate in harsh areas or places which would be hard to reach by humans

Since these sensors communicate via wireless networks, they are ideal tools to use in monitoring remote or otherwise hostile environments such as: underground caverns, ocean floors, volcanic mountain ranges, etc. [1]. Another field in which wireless sensors would represent a good monitoring solution is geodynamics. Using such a network, it could be

possible to predict natural phenomena such as earthquakes, tsunamis, landslides and volcanic eruptions much faster and with increased precision regarding magnitude and the time of the event. Also, such a solution may prove to be cheaper and more flexible than existing installations deployed for performing these tasks.

Furthermore, as proven in a previous paper by I. Deaconu and A. Voinescu [2], these types of wireless sensor networks which are mounted in remote locations over a wide area do not require an expensive network infrastructure in order to communicate with them. Drones can be used as mobile gateways to collect data and check the status of the sensor nodes.

Delving even deeper into the utility of such an application, it is a known fact that whenever a phenomena amongst those mentioned earlier occurs, the areas which often suffer a significant amount of damage are cities and towns. A good use for a wireless sensor network would be to mount it around a city and on buildings inside the city situated in such danger zones. Thus, whenever an earthquake or other natural disaster may occur, authorities can respond faster and reduce the damage, both material and human lives.

This paper proposes a wireless sensor network solution for monitoring earthquakes. The nodes can be mounted on buildings and they will monitor the vibration of the building as well as various other parameters (air pressure, temperature, etc.). Once calibrated to the normal values of the parameters, whenever these parameters go over a threshold value, a system is notified that there is a possible risk of an earthquake happening. More so, this system can be used to determine if a building is exposed to deterioration due to external factors such as proximity to construction site, roads frequented by heavy load trucks, etc.

In the Architecture section presents how the SparrowV4 sensor's hardware and software components are designed and interconnected. Then, in the Experimental section, the laboratory tests which were ran in order to determine the viability of these sensors are presented. The Results section shall analyze the data acquired during the tests and show that the SparrowV4 wireless sensor nodes are reliable. Finally, in the Conclusions and Future Work sections, improvements are

proposed in order to increase the robustness and efficiency of the system.

II. RELATED WORK

Applications which monitor geodynamics using wireless sensor networks have been attempted before. However, most have been used to monitor volcanic activity [3], the seismic waves or tsunamis that follow large seismic events and building structure integrity [4][5]. While there have been previous attempts at monitoring earthquake activity directly by using wireless sensor networks [6], the proposed systems suffer from low accuracy and high energy consumption.

Researchers from Singapore, China and the USA have published a paper describing their implementation of an improved algorithm for wireless sensor networks in order to monitor volcanic activity [7]. This new algorithm, using data gathered from the sensors, would determine as accurately as possible and in real time the arrival of primary seismic waves [8] which are produced prior to a volcanic eruption. Although not directly focused on earthquake monitoring, this research provides a starting point for further research and improvements in this area.

Another implementation using wireless sensor networks is presented in an article by N. Meenakshi and Paul Rodrigues [9] and focuses on tsunami monitoring. They propose a network composed of three types of nodes: sensors, commanders and barriers. The sensors are dispersed underwater to monitor the water pressure. This data is sent to commanders which process it and determine if there is any specific area in danger of being hit by an incoming tsunami, determined by the variations in pressure. If there is any danger, the barrier sensors in that area are notified to activate the barriers.

One more direction in which geodynamic monitoring wireless sensor networks have been used is structural integrity of buildings [10]. Especially in urban areas, buildings are often exposed to vibrations caused by various factors: heavy vehicles such as public transport or cargo trucks, proximity to construction sites, etc. In time, such buildings deteriorate and become a danger because they are prone to collapsing. Using such sensors to monitor the vibrations they are exposed to, damage can be prevented by determining if a building is prone to collapsing and if it poses a threat to people and other structures in the area.

III. SYSTEM ARCHITECTURE

A. Hardware description

The Sparrow v4 wireless sensor nodes were designed and built by the authors to be a versatile mobile platform for use in various research projects. They are designed as a single PCB board which hosts all of the major components, such as:

- Atmega128RFA, 8-bit microcontroller with RISC architecture, 128 kB of Flash, 4kB of EEPROM, 32 kB of SRAM and a 16 MHz clock speed
- integrated RF transceiver compatible with ZigBee and IEEE 802.15.4

- LSM9DS0 - 16 bit high resolution 3-axis accelerometer, 3-axis gyroscope and 3-axis magnetometer with embedded FIFO
- SI7020 - humidity and temperature sensor
- SI1145 - infra-red proximity detection, UV and ambient light sensor
- MPL3115A2 - pressure, high precision altimeter and temperature sensor
- CR2032 - 3V lithium ion battery

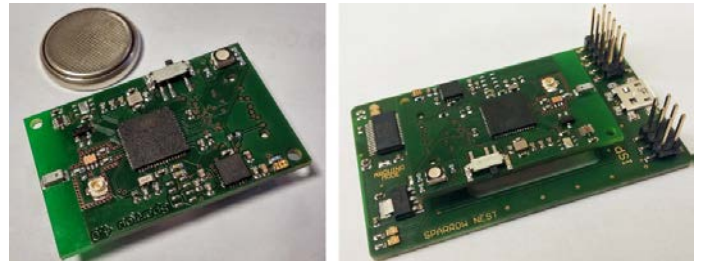

Fig. 1. SparrowV4 wireless sensor nodes

The main processing unit of the Sparrow v4 nodes is an ATmega128RFA1 micro controller, which hosts an on-chip transceiver, fully compatible with 2.4 GHz IEEE 802.15.4/ZIGBEE protocols. The low power, ATmega128RFA1 microcontroller is connected to all of the node's sensors and its main function is to process the data received from them and pass it on via the RF transceiver. The transceiver is a low power wireless transmission chip capable of sending signals to distances of up to a few hundreds of meters if using a high gain antenna on both devices, according to the official datasheet. It also provides an AES-128 compatible security module for data encryption and decryption.

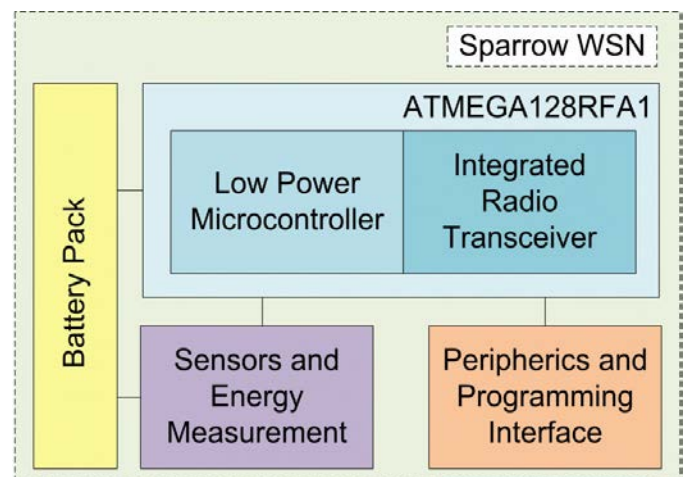

Fig. 2. SparrowV4 hardware architecture

The sensor that was involved in earthquake and vibration monitoring is a LSM9DS0 IMU (Inertial Measurement Unit). This chip has three channels for linear acceleration measurement, three channels for angular rate measurement and another three channels for magnetic field measurement. All data measurements are performed at a very accurate 16-bit

resolution, which is paramount in order to detect even the faintest tremors. The metric we used by in this application is the linear acceleration which is measured in relation with the sea-level standard gravitational acceleration of 1g).

The nodes can be easily programmed from a computer using the specially designed programming interface. This interface represents a separate circuit board on which the Sparrow nodes can be mounted, and it is only needed during programming. Using the adapter board, the nodes can be programmed using a normal USB connection without the need of any additional component.

B. Software Architecture

The Sparrow v4 wireless sensor nodes run an Arduino compatible firmware. This allows the programmer to easily import and use open source Arduino modules for each peripheral. Another advantage of using an Arduino compatible firmware is that it ensures the code is compatible with multiple platforms and can be easily modified, upgraded or ported to similar hardware. For development, the Arduino IDE is used because it provides access to pre-defined libraries for peripherals such as serial line, two-wire interface and ADC. It is also available on a wide variety of operating systems which makes code modifications and firmware updates easier to implement.

The firmware which runs on the Sparrow v4 nodes operates in two steps. The first step is a calibration phase, which starts running when the sensor is first turned on. This will determine the default values for each of the three accelerometer axes for the current position of the node. Once this step is completed, the node enters its second step in which it will continuously run the environment monitoring algorithm. During this period, it harvests data from the accelerometer and sends it towards a designated gateway. The gateway shall always be connected to a server which is capable of plotting and analysing the data. The gateway communicates with this server by means of a serial interface.

The monitoring algorithm mentioned earlier is designed as a state machine with three main states: SLEEP, READ DATA, and NOTIFY.

The algorithm starts in the SLEEP state. In this state, most peripheral components of the Sparrow V4 sensor node are turned off in order to increase the autonomy of the sensors. Only the accelerometer functions in this state in order to gather data. Every 0.5 seconds, the algorithm transits from the SLEEP state into the READ DATA state. The latest data harvested by the accelerometer is read and analyzed. If the data shows readings with values around a set threshold, the algorithm transits into the NOTIFY step, otherwise it goes back into SLEEP state. In the NOTIFY state, the sensor sends the event to the base station and then returns to its normal state, the SLEEP state.

The accelerometer on the Sparrow v4 node is configured for a 2 g linear acceleration rate and operates at an output data rate of 50Hz. The raw data from the three axes is translated by the ATmega128RFA1 microcontroller into gravitational scale and then is normalized.

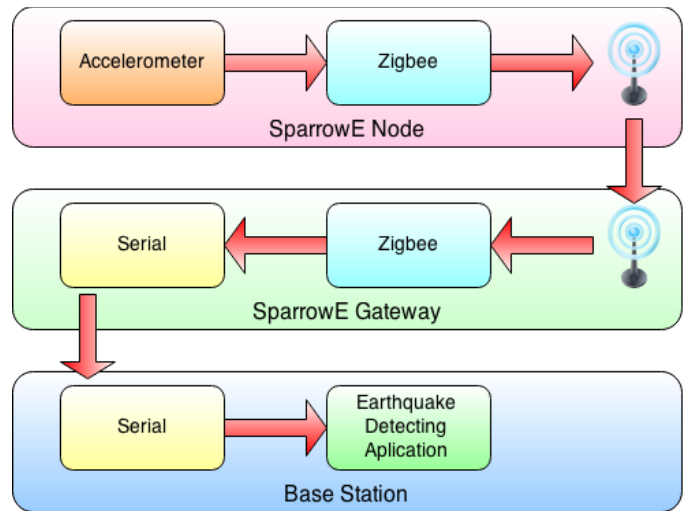

Fig. 3. Software architecture and module connections

This approach will generate a value of 1 g when the node is kept still, in its calibrated position. When the surface starts vibrating, the value will start varying above or below the reference value of 1 g. The calculated data is gathered in sent periodically by the controller to the gateway. Node identification data is also added to the sent packets. The gateway is able to collect data from multiple nodes and send it to the base station through a serial connection, which is configured at a baud rate of 1Mbps. The base station is responsible for saving and interpreting the data. It is considered that a node has detected an earthquake if the values oscillate strongly over the 1 g reference value, reaching peaks at more than 2 g.

C. Low Power Considerations

The goal of the sensors is to monitor earthquakes and similar phenomena over prolonged periods of time. It must be ensured that the Sparrow v4 sensors function in a low power state and capable of running for prolonged periods of time. This problem is tackled mainly at the software level. At the hardware level, while the components of the sensor are selected with regard to power consumption, their power consumption is still relatively high considering the target autonomy of the Sparrow v4 sensor.

In order to overcome this, the firmware is designed to keep the controller in a sleep state and wake it up periodically to read the accelerometer data. This technique is similar to clock gating and it is done with the use of a RTC (Real Time Clock). The ATmega128RFA1 controller on the nodes offers the ability of using a Timer peripheral as a real time clock source with an external 32.768kHz crystal oscillator. The reason why a real time clock is used to implement this mechanism is that even while the controller is in sleep mode, this peripheral is still active and it will generate interrupts at certain time intervals, as configured by the programmer. When the controller receives such an interrupt, it will wake up and perform any designated operation after which it is put back to sleep and the entire process starts again.

Using this technique, the data from the accelerometer is read and sent to a base station once every half of second instead of once every hundred milliseconds. By doing this, the battery is preserved for much longer, as the controller and the transceiver operate for shorter periods of time. The only component with 100 per cent uptime is the accelerometer. According to the datasheet of each individual component, the accelerometer's consumption in normal mode is 350 μ A, while the ATmega128RFA1's consumption is 4.7mA in normal mode and 0.2 μ A in sleep mode. In theory, the sensors should never have an average power consumption higher than 1mA. An example of the actual power consumption over the course of 1.1 seconds of activity can be seen in Fig. 4.

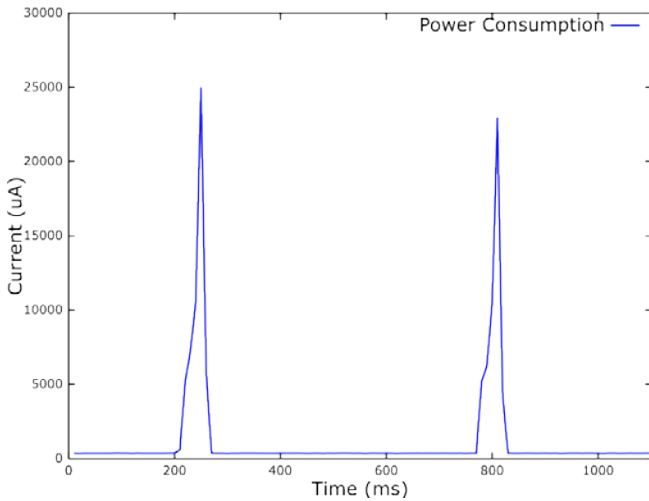

Fig. 4. Typical power consumption profile when periodically sending data packets.

While the controller is put into a sleep state, the accelerometer is always powered on and functioning. The LSM9DS0 chip comes with 192 bytes of memory where it can store the data it reads. This allows the controller to always read the latest data from the accelerometer while relaying the oldest to the base-station. Because the accelerometer is set at a 50Hz ODR, the FIFO queue will fill in less than a second. So every other 500 milliseconds data is read from the FIFO buffer, processed and the normalized values are sent to the base station. By doing so, the sensor nodes will be prompt when it comes to detecting events but, at the same time, they will maintain a low power state by transmitting data in smaller quantities over longer periods of time.

With this approach, the autonomy of the Sparrow v4 sensor node is increased while, at the same time, making data easier to handle by the plotting and interpretation software running on the base station.

Data is also saved inside the 4kB EEPROM of the CPU. The data is saved as a circular FIFO, with two pointers, one for the oldest data and one for the newest data. In case the communications are down, lost data can be recovered from the EEPROM memory. In order not to wear down the memory due to excessive writes, the data is stored in RAM, and once every 30 minutes it is saved in EEPROM.

Furthermore, if vibrations of a set threshold are detected, the data is again saved in the EEPROM, so that in case an earthquake destroys the power supply of the wireless sensor node, data could still be retrieved from memory at a further date.

IV. EXPERIMENTAL SETUP

In order to test the accuracy and capability of the Sparrow v4 wireless sensor nodes, a shake table was built in order to simulate the movements of a building during an earthquake. The purpose of the experiment is to see if the Sparrow v4 nodes can detect the vibrations produced by the main waves which are felt during an earthquake, P-waves and S-waves.

To perform the simulations, an experimental rig was built, as is presented in Fig. 5.

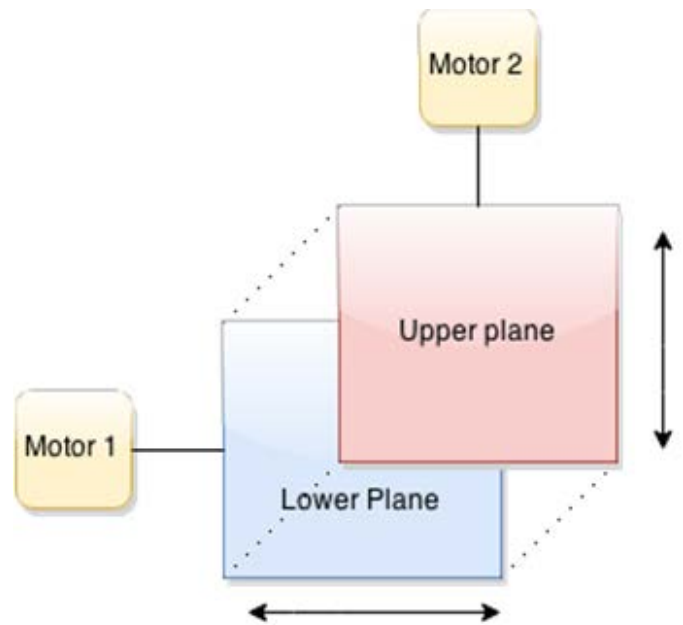

Fig. 5. Experimental moving frame rig diagram

This rig uses a movable frame as its base, and a tall, layered shelf mounted on top of it. The frame is composed of two separate planes which are moved individually by two DC motors. One plane produces left-right movement, while the other moves the shelf forward and backward. The planes are connected to the corresponding motor via a crank whose length can be adjusted, thus giving the ability to control the amplitude of the oscillations. Smaller amplitudes will result in sudden and violent oscillations while higher amplitudes will allow the shelf to sway more.

The experimental setup tries to emulate the effects of these waves on a tall building which has Sparrow v4 nodes mounted on its sides, as presented in Fig. 6. The purpose of the experiment is to see how accurate the data harvested by the IMU is and how the amplitude of the movement varies from floor to floor.



Fig. 6. Sparrow wireless sensor nodes mounted on the experimental rig

V. EXPERIMENTAL RESULTS

The tests were conducted using 4 sensor nodes connected to a gateway. The nodes were placed one on each shelf of the experimental rig in order to see how the height of the shelf affects vibrations, similar to a tall building. The nodes were securely mounted and calibrated until they were stable enough to not be affected by small vibrations which could corrupt the actual data. This would also apply to a real world scenario, where the nodes would need rigid mounting to the structural frame of the building.

Four test runs were conducted by setting the supply voltage for the shake table's motors at different values. The shake table was powered on for 3 seconds during each test run. The first test is performed with a still table to verify just how sensitive the sensor nodes are. Then, three types of vibrations generated by different movements were simulated: small vibrations obtained by swaying the test table, medium vibrations obtained by shaking the test table and large vibrations obtained by violently shaking the test table.

Two specific results from this experiment are of importance. First, it is important that the sensor readings are proportional to the type of vibration applied to the experimental rig. Second, a correlation needs to be established between sensor readings and height, as structural oscillations during seismic events have a higher amplitude as height increases.

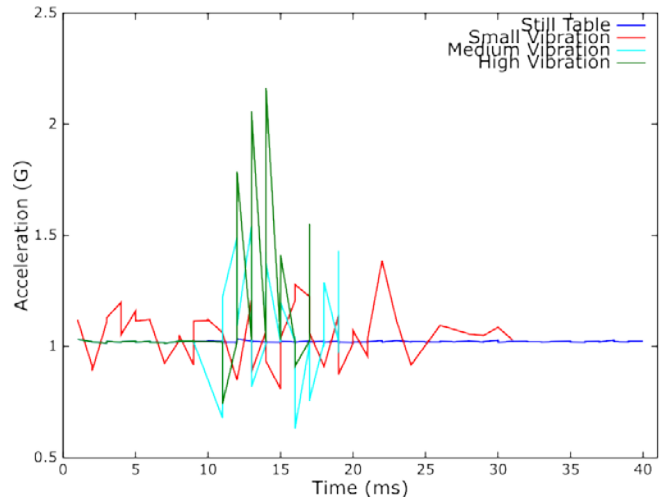

Fig. 7. Results for Sensor Node 4 at different oscillation amplitudes

In Fig. 7 the accelerometer readings are shown for the sensor placed on the lowest shelf (Sensor ID 4) of the experimental rig taken during each test run. The readings show that while the table is still, the sensor is stable and does not present any relevant activity. As the intensity of the vibrations increases, more and more spikes appear in the readings and they start reverting to normal as the vibrations stop. This shows that the Sparrow v4 sensors can reliably record seismic events of different magnitudes.

Another observation can be made regarding the calibration step. As it can be seen in Fig. 8, while the normal value for the other sensors is around 1g, sensor node 6 is slightly below this value. This happens because not all IMU modules are identical by fabrication, and it must be taken into account when interpreting the data. It also shows why the calibration step is important and necessary.

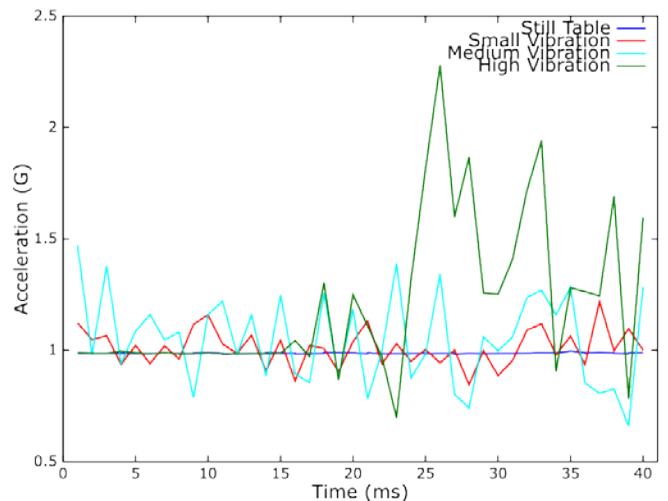

Fig. 8. Results for Sensor Node 6 at different oscillation amplitudes

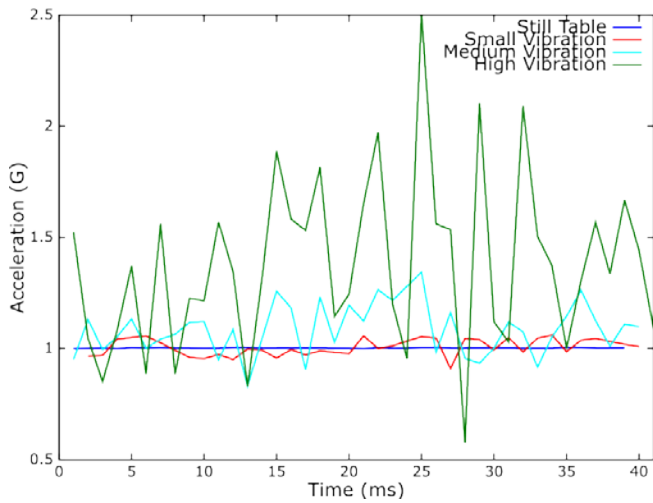

Fig. 9. Results for Sensor Node 5 at different oscillation amplitudes

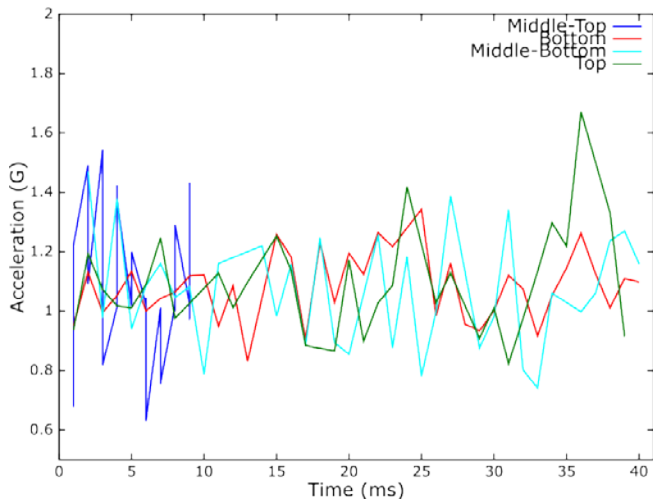

Fig. 10. Results for all sensor nodes at the same oscillation frequency

One final test performed with the sensors on the shake table was to place them in the middle of a shelf, instead of placing them on the side. In theory, if the material is too elastic or the structure is not properly built to absorb shocks, its weakest point would be in the very middle. This means that after an intense vibration, the sensors would still be getting readings of over 1G even after the source of the vibrations (suppose an earthquake) no longer exists.

The experimental setup had the shake table running at different intensities for 60 seconds and then, after the rig has been switched off, the sensors would continue recording for another 40 seconds. These last 40 seconds have been plotted in Fig. 11 for sensor node 4, which was placed at the lowest level, and Fig. 12 for sensor node 5, which was placed at the highest level. It can be seen that sensor 4 is still sending readings, but they are nothing too significant, being under 1.5 g. For sensor 5, the same applies for small and, to some extent, medium intensities. However, once high intensity vibrations are achieved by reaching resonance with the structure of the table. Due to the elastic nature of the table's material, readings that

reach 2 g are still being received. This shows the potential use of the sensors to detect eventual flaws in the structure of buildings.

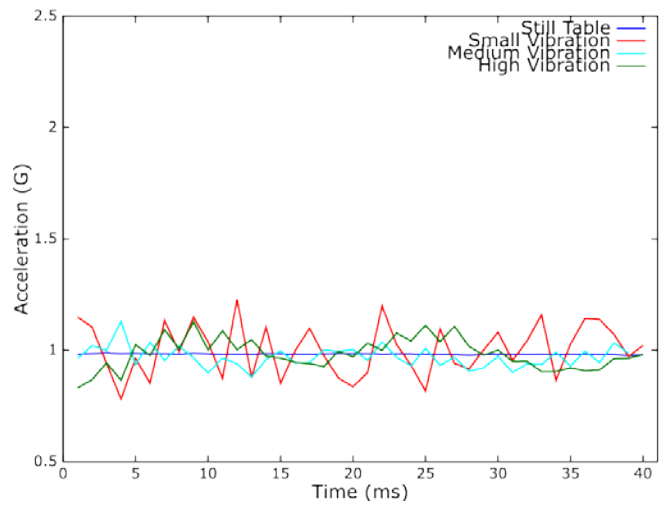

Fig. 11. Results for Sensor Node 4 placed in the middle of the shelf

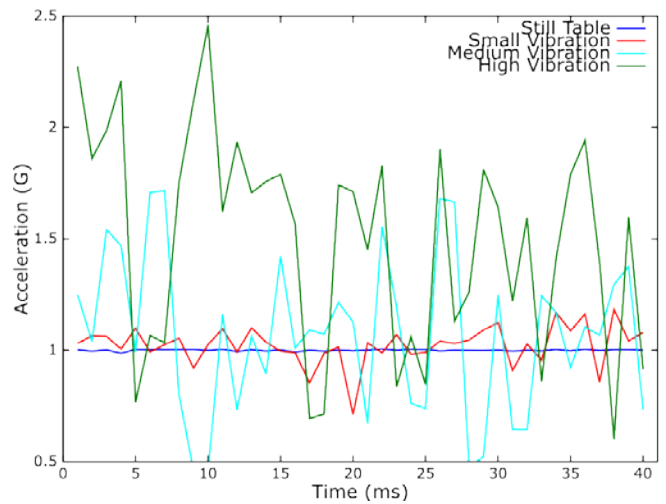

Fig. 12. Results for Sensor Node 5 placed in the middle of the shelf

VI. CONCLUSIONS AND FUTURE WORK

A. Conclusions

This paper, through the previously presented experiment, shows that the Sparrow v4 wireless sensor node is a viable tool for monitoring earthquake activity. It is also versatile as it can fulfil multiple purposes and tasks. Sparrow v4 nodes can be placed in key points on a structure to monitor the amount of vibrations which it is exposed to. Alternatively, the nodes can be organized in a wireless sensor network and can be used to monitor seismic activity in certain areas. They can act as a tool which is used to predict earthquakes and warn authorities in case of danger.

The results have shown that the experimental rig is responding similar to a tall building because the lower positioned nodes gather lower amplitude values than the ones

located on higher shelves when the table is vibrating. At the end of the simulation, when the table is no longer being shaken and it is naturally vibrating due to previous forces, the higher positioned nodes continue to detect vibrations, as it is most likely to happen in the case of a real building. Even more, the system could detect flaws in various structures and prevent real earthquakes from causing their collapse.

Furthermore, because the sensor nodes are low power, no matter in which type of application they are used, they will be able to function for prolonged periods of time, which makes them ideal for monitoring environments.

B. Future Work

The Sparrow v4 sensor nodes can be further improved by adding energy harvesting modules to their current design. Allowing them to harvest resources such as solar power can further increase their autonomy and efficiency. Furthermore, there is the possibility of designing a node which needs even less power to function. This can be achieved mainly by swapping the microcontroller with an Atmel SAM R21, which brings the following advantages compared to the existing one:

- 32 bit architecture instead of 8 bit architecture
- 256 kB of FLASH memory instead 128 kB. 150kB flash endurance instead of 50kB, and 16kB EEPROM emulation with 600.000 write cycles endurance instead of a 4kB EEPROM with 100.000 write cycles. This will allow larger quantities of data to be stored more often, making the sensors more efficient
- 64 kB of SRAM memory. This will allow for more complex programs and algorithms to be uploaded on the sensors
- Higher operating frequency, 48 MHz instead 16 MHz. This improvement does not affect power consumption. It is maintained at 5 mA, just like the current sensor's consumption
- 70 per cent smaller footprint; 32 QFN instead of 64 QFN. This allows for smaller nodes that can be mounted more easily.
- Small improvement in transceiver's power efficiency and transmission power: 4 dB instead of 3.5 dB
- 12 bit ADC instead of 10 bit ADC for improved sensor reading accuracy

Another component which can be replaced with an improved version is the accelerometer. There are models which have a consumption of only 6uA for a 50Hz ODR. However, the trade-off for these changes would be a slight increase in the cost of the nodes.

While we have proven that the sensors can be used to detect earthquakes and other vibrations, in order to increase their accuracy and reliability they will have to be calibrated with the help of National Institute of Earth Physics. This will allow users to precisely determine the intensity of the earthquakes and find new ways of using the data provided by the sensors.

This would also enable the use of an Android application based on crowd-sourcing that can warn citizens of an upcoming earthquake.

The mobile phones can be considered as the largest available network of wireless sensors. They have the ability to send data using wireless interfaces and they are built with similar accelerometers and IMU chips as the ones that we have installed on our node. This means that, given a large enough sample base, they could be able to detect earthquakes. With the application installed, if the phone is left still on the table, it could detect and warn a person in real time if an earthquake is about to happen.

Research by Faulkner et al. has already been made on this supposition [11]. It has proven that phones could be used as an earthquake sensing device, not only in a stationary position, but also in a dynamic scenario, when carried by a person.

REFERENCES

- [1] El-Bendary, N., Fouad, M. M. M., Ramadan, R. A., Banerjee, S., & Hassanien, A. E. (2013). Smart environmental monitoring using wireless sensor networks. *Wireless Sensor Networks: From Theory to Applications Book*, CRC Press, USA.
- [2] Deaconu, I.; Voinescu, A., "Mobile gateway for Wireless Sensor Networks utilizing drones," in *RoEduNet Conference 13th Edition: Networking in Education and Research Joint Event RENAM 8th Conference, 2014*, vol., no., pp.1-5, 11-13 Sept. 2014
- [3] Werner-Allen, G., Lorincz, K., Ruiz, M., Marcillo, O., Johnson, J., Lees, J., & Welsh, M. (2006). Deploying a wireless sensor network on an active volcano. *Internet Computing, IEEE*, 10(2), 18-25
- [4] Kim, S., Pakzad, S., Culler, D., Demmel, J., Fenves, G., Glaser, S., & Turon, M. (2007, April). Health monitoring of civil infrastructures using wireless sensor networks. In *Information Processing in Sensor Networks, 2007. IPSN 2007. 6th International Symposium on* (pp. 254-263). IEEE
- [5] Kurata, N., Spencer, B. F., & Ruiz-Sandoval, M. (2005). Risk monitoring of buildings with wireless sensor networks. *Structural Control and Health Monitoring*, 12(3-4), 315-327.
- [6] Suzuki, M., Saruwatari, S., Kurata, N., & Morikawa, H. (2007, November). A high-density earthquake monitoring system using wireless sensor networks. In *Proceedings of the 5th international conference on Embedded networked sensor systems* (pp. 373-374). ACM.
- [7] Liu, G., Tan, R., Zhou, R., Xing, G., Song, W.Z., and Lees, J.M. (2013). Volcanic earthquake timing using wireless sensor networks. In *Proceedings of the 12th international conference on Information processing in sensor networks*, 91-102. ACM.
- [8] Ben-Menahem, A. and Singh, S.J. (2012). Seismic waves and sources. *Courier Corporation*.
- [9] Meenakshi, N. and Rodrigues, P. (2014). Tsunami detection and forewarning system using wireless sensor network-a survey. 76-79.
- [10] Torfs, T., Sterken, T., Brebels, S., Santana, J., van den Hoven, R., Spiering, V., Bertsch, N., Trapani, D., and Zonta, D. (2013). Low power wireless sensor network for building monitoring. *Sensors Journal, IEEE*, 13(3), 909-915.
- [11] Faulkner, M., Olson, M., Chandy, R., Krause, J., Chandy, K. M., & Krause, A. (2011, April). The next big one: Detecting earthquakes and other rare events from community-based sensors. In *Information Processing in Sensor Networks (IPSN), 2011 10th International Conference on* (pp. 13-24). IEEE.